

# TOWN OF FREEDOM FREEDOM, NH 03836

## ZONING-BUILDING PACKET

OFFICE HOURS: BY APPOINTMENT

OFFICE PHONE: 539-6323

CELL PHONE: 986-0486

Email: [freedomzoning@townoffreedomnh.gov](mailto:freedomzoning@townoffreedomnh.gov)

### GENERAL INSTRUCTIONS

*Important: Read carefully before filling out and submitting an application.*

**All appropriate sections of the attached form must be completely filled out. The form provides information you need as well as references to applicable sections of the Freedom Zoning Ordinance.**

The zoning officer cannot act on this application unless you include:

- Include a signed or stamped “*Local Approval for construction of an individual sewage disposal system.*” (Zoning ordinance section 2302.3)
- If the property is located on a town road, include the two page, approved “*Driveway Permit*” signed by the Road Agent. If there is not an approved driveway permit on file, the applicant must file an application and obtain a current approval. (Zoning ordinance section 805)
- If the property is located on a state road, include a state-approved driveway permit. (Zoning ordinance section 805) Find the application at:  
<https://www.nh.gov/dot/org/operations/highwaymaintenance/documents/DrivewayPermitFormHandWrittenEntries.pdf>

**MAIL OR DELIVER** The completed application to the Zoning Officer at the town of Freedom. You can mail it or leave it in the mail slot in the foyer of the town office. **Please note, it may take up to 30 days to approve or deny a zoning application.**

# TOWN OF FREEDOM ZONING PERMIT APPLICATION

## 1. Owner Information

Owner \_\_\_\_\_ Date: \_\_\_\_\_  
 Permanent Address: \_\_\_\_\_ Phone # \_\_\_\_\_  
 E-mail Address: \_\_\_\_\_ Cell# \_\_\_\_\_

## 2. Property Information

Property Address: \_\_\_\_\_ Phone: \_\_\_\_\_  
 Map# \_\_\_\_\_ Lot# \_\_\_\_\_ Lot Size (acres) \_\_\_\_\_ Zoning District \_\_\_\_\_  
 You can find the first 3 items on your tax bill. Check zoning district with zoning officer.

Is this property non-conforming by area? (Section 803) Yes No

Zoning District	Min. Lot Size	Zoning District	Min. Lot Size
Village Residential (VR)	1 acre	Residential/Light Commercial (R/LC)	5 acres
General Residential (GR)	2 acres	Shorefront GR	2 acres
Rural Residential (RR)	1 acre	Shorefront RR	1 acre

Does the property have town water or a private well? \_\_\_\_\_

What class road does the property border on? \_\_\_\_\_

See page 10 for a list of town roads to find this information.

Are there any easements or rights of way on the property? \_\_\_\_\_ Yes No

Does this property lot have a tax exemption because part/all acreage is in current use? \_\_\_\_\_ Yes No

If there are prior zoning applications concerning the property, include the application and a Plot Plan

Is this property on a corner—i.e., borders on two different streets? (Section 803) \_\_\_\_\_ Yes No

Are there wet areas or wetlands on the property? (Section 403 to 306, Article 6) \_\_\_\_\_ Yes No

Is the property 0.5 acres or less? Section 310.1.7 \_\_\_\_\_ Yes No

Is the property in the floodplain? See Floodplain Ordinance <https://townoffreedom.net/regulations/> \_\_\_\_\_ Yes No

## 3. Current Property Use—check all that apply

Residential (existing home) \_\_\_ # of current bedrooms \_\_\_ Accessory buildings only \_\_\_ Raw Land \_\_\_  
 In Current Use \_\_\_ Commercial \_\_\_ Camp/Campground \_\_\_ Home Occupation: Minor \_\_\_ Major \_\_\_  
 Other \_\_\_ Specify \_\_\_\_\_

## 4. Proposed Project

Describe **all parts** of the proposed project (new construction, removals, replacements, new rooms, etc.)

\_\_\_\_\_  
 \_\_\_\_\_

Total Square Feet of Project \_\_\_\_\_ Proposed start date \_\_\_\_\_

Is this use permitted or does it require a special exception? Permitted \_\_\_\_\_ Special exception \_\_\_\_\_  
 See page 11-12 for a list of permitted and special exception uses by district

Will the height of any structures be altered? Section 308.3.1 \_\_\_\_\_ Yes No

Will the total footprint of all structures exceed 15% lot coverage? Section 310.1.6 \_\_\_\_\_ Yes No

Will the project expand a non-conforming structure? By what %? Section 906 \_\_\_\_\_ Yes No

Does the project comply with all parking requirements? Section 1104.1 \_\_\_\_\_ Yes No

If the proposed building a manufactured home, does it meet the requirements? Section 1107 \_\_\_\_\_ Yes No

Is the property adjacent to a stream Section 602-603 \_\_\_\_\_ Yes No

See table of streams on page 13.

If yes, provide a stormwater management plan. (See pages 14-18).

Will any additional water flow off the site to an abutter's property or town road (Section 602-3) \_\_\_\_\_ Yes No

If yes, provide a stormwater management plan (See pages 14-18)

### 5. Present and Proposed Construction

Boundary lengths (in feet). If you have a surveyed plot plan, please use that data. If not, go to <https://townoffreedom.net/tax-maps/> to select your tax map, then find your lot number for the data.

Lot road frontage: \_\_\_\_\_ Left boundary: \_\_\_\_\_ Right boundary: \_\_\_\_\_ Rear boundary: \_\_\_\_\_

List the setbacks for building(s) **presently** on your property? Include all building overhangs in your measurements. (Tables 304.1 to 304.6)

Building name	Front (on road)	Right boundary	Left boundary	Rear boundary
Required setback	50 feet	30 feet	30 feet	40 feet Shorefront 75 feet

What are the setbacks for the **proposed** structure(s)?

Building name	Front (on road)	Right boundary	Left boundary	Rear boundary
Required setback	50 feet	30 feet	30 feet	40 feet Shorefront 75 feet

#### **Address the following if property in the shorefront district**

Any proposed structures within 300' of reference line? Table 304.5 \_\_\_\_\_ Yes No

Will the project require any earth work? Section 304.6. \_\_\_\_\_ Yes No

Is there a need for erosion control? Section 304.6.3 \_\_\_\_\_ Yes No

Is there any tree cutting within 75'? Section 703.4 and Section 304.6.5 \_\_\_\_\_ Yes No

Is there tree cutting beyond 75' with a grade of 12.5% or greater? Section 305.6.5.3 \_\_\_\_\_ Yes No

Do the impervious surfaces on the lot exceed 25%? Section 704 \_\_\_\_\_ Yes No

Is any State shoreland approval needed? \_\_\_\_\_ Yes No

Follow the link below for instructions and to download form at bottom of page if needed:

<https://onlineforms.nh.gov/app/#/formversion/282248b1-10d0-4046-9d49-e85d148c09a3>

**PLOT PLAN**

Date: \_\_\_\_\_

Map \_\_\_\_\_ Lot \_\_\_\_\_ Property Address: \_\_\_\_\_

Owner Name(s): \_\_\_\_\_ Phone: \_\_\_\_\_

In the space below draw (to scale)

1. The boundaries and shape of your lot and mark the boundary distances
  2. Show all present and proposed buildings in their correct location and indicate dimensions (in feet).
- Orient your drawing so the road is at the bottom of the diagram. A survey of your property may be required as part of this application.

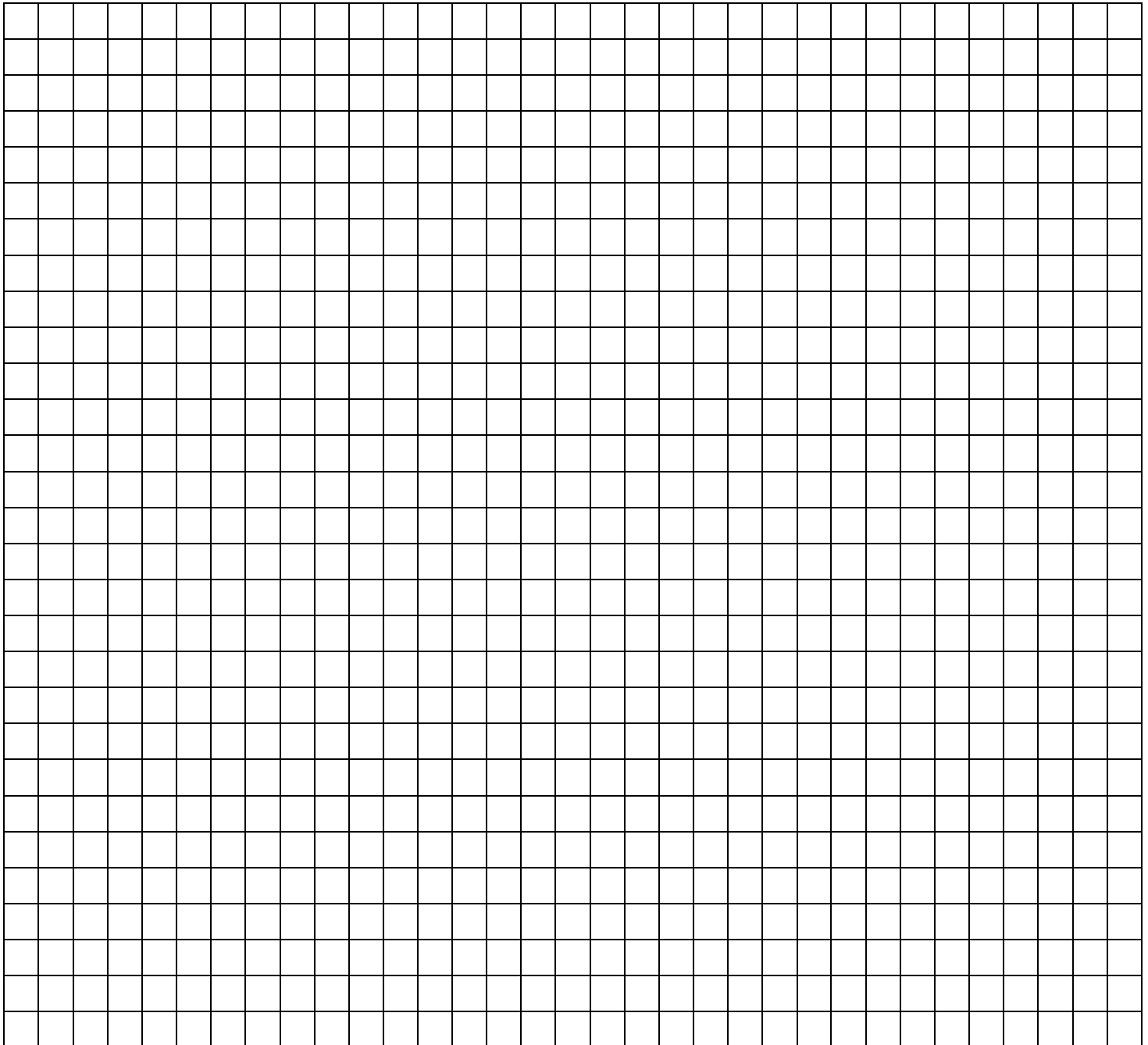

**SIGNATURES**

**The undersigned owner hereby requests a zoning permit for the above use, to be issued based on the representations contained herein. Permit is void in the event of misrepresentation and/or not being in compliance with the zoning ordinance, site plan review, subdivision regulations (if applicable) and other applicable state and town laws and regulations. Construction is not authorized until a building permit is issued. By signing below, owner acknowledges and allows access to property for inspection regarding this proposed work.**

**This application must be submitted by and signed by all owners of the property listed on this application.**

Signature \_\_\_\_\_ Date \_\_\_\_\_

Print name \_\_\_\_\_

Property owner

Signature \_\_\_\_\_ Date \_\_\_\_\_

Print name \_\_\_\_\_

Property owner

Signature \_\_\_\_\_ Date \_\_\_\_\_

Print name \_\_\_\_\_

Property owner

Signature \_\_\_\_\_ Date \_\_\_\_\_

Print name \_\_\_\_\_

Property owner

**If you are using an agent for this application, provide the information below:**

**Designation of agent**

I designate the person listed below as my agent for the purpose of procuring the necessary local permits for the proposed work as described herein. Representations made by my agent may be accepted as though made by me personally, and I understand that I am bound by any official decision made based on such representations.

Agent \_\_\_\_\_ Telephone # \_\_\_\_\_

Address \_\_\_\_\_

Owner's signature \_\_\_\_\_

Owner's signature \_\_\_\_\_

Owner's signature \_\_\_\_\_

Owner's signature \_\_\_\_\_

**Zoning Officer Decision**

**The zoning officer is required to deny an application under Section 2303, if:**

- The application is for a use that requires a special exception
- The application requires a variance

Only the ZBA is the body that can grant either of the above.

Approved \_\_\_\_\_ Date \_\_\_\_\_ Zoning Officer \_\_\_\_\_  
 Denied \_\_\_\_\_ Date \_\_\_\_\_ Zoning Officer \_\_\_\_\_

Reason for Denial:

Article: \_\_\_\_\_ Section: \_\_\_\_\_ - \_\_\_\_\_  
 Article: \_\_\_\_\_ Section: \_\_\_\_\_ - \_\_\_\_\_  
 Article: \_\_\_\_\_ Section: \_\_\_\_\_ - \_\_\_\_\_  
 Article: \_\_\_\_\_ Section: \_\_\_\_\_ - \_\_\_\_\_

If the zoning officer denies the application, the applicant may appeal this decision to the Zoning Board of Adjustment. Please use the Zoning Board Application found on the town's website, [www.townoffreedom.net](http://www.townoffreedom.net).

ZBA Tips:

- Application and Appointment of Agent Form must be completed and signed by all owners of the property.
- Abutter letters go directly to ZBA at PO Box 227, Freedom, NH 03836
- The applicant is responsible to fulfill all requirements from the ZBA and provide the necessary information. The applicant is responsible for reading the regulations. The Zoning Officer's role is to help the applicant complete the application if the applicant requests help.
- To be considered by the ZBA, an application must be significantly different from a previous application which the ZBA has previously denied.
- If the ZBA approves the special exception or variance, the application will come back to the zoning officer for action. The zoning officer will determine that the applicant has met all conditions imposed by the ZBA and sign below.
- The ZBA approval can be appealed within 30 days of the decision.

**Once the zoning officer has signed the application, it can go to the Building Department.**

**FOR USE IF THE APPLICANT'S ORIGINAL APPLICATION IS DENIED AND THE ZBA HAS APPROVED THE PROPOSED PROJECT**

**Approval below signifies that the applicant has submitted proof that they have met all conditions listed by the zoning board of adjustment.**

Approved \_\_\_\_\_ Date \_\_\_\_\_ Zoning Officer \_\_\_\_\_

Per ZBA decision dated: \_\_\_\_\_



# TOWN OF FREEDOM APPLICATION FOR BUILDING PERMIT

Tax Map # \_\_\_\_\_ Lot # \_\_\_\_\_  
Application Date \_\_\_\_\_  
Permit # \_\_\_\_\_ Fee: \_\_\_\_\_  
By \_\_\_\_\_

See building permit fee schedule on page 8 and building code requirements on page 9

### 1. Owner Information

Owner \_\_\_\_\_ Date: \_\_\_\_\_  
Permanent Address: \_\_\_\_\_ Phone # \_\_\_\_\_  
E-mail Address: \_\_\_\_\_ Cell# \_\_\_\_\_

### 2. Property Information

Property Address: \_\_\_\_\_  
Map# \_\_\_\_\_ Lot# \_\_\_\_\_ Lot Size (acres) \_\_\_\_\_ Phone \_\_\_\_\_  
NH Septic Approval# \_\_\_\_\_ Date \_\_\_\_\_ # of Bedrooms \_\_\_\_\_  
NH Energy Code Approval# \_\_\_\_\_

3. Contractor/Builder Name: \_\_\_\_\_ Company: \_\_\_\_\_  
Address: \_\_\_\_\_ State/Zip \_\_\_\_\_ Phone \_\_\_\_\_

4. Reason for Permit  New Structure  Addition  Remodel  Alteration  Change of Use  
 Res  Comm  Ind Type of Business \_\_\_\_\_ Type of Mfg. \_\_\_\_\_  
# Of Stories \_\_\_\_\_  Frame  Metal  Masonry  Other \_\_\_\_\_  
Size of Building Width \_\_\_\_\_ Length \_\_\_\_\_

<u>Foundation</u>	<u>Basement</u>	<u>Exterior Walls</u>	<u>Insulation</u>	<u>Interior finish</u>	<u>Heating</u>
<input type="checkbox"/> Concrete	<input type="checkbox"/> Full	<input type="checkbox"/> T-111	<input type="checkbox"/> Blanket	<input type="checkbox"/> Drywall	<input type="checkbox"/> Electric
<input type="checkbox"/> Cement Block	<input type="checkbox"/> Finished	<input type="checkbox"/> Clapboard	<input type="checkbox"/> Wall Roof	<input type="checkbox"/> Paneling	<input type="checkbox"/> Oil
<input type="checkbox"/> Other	<input type="checkbox"/> Other	<input type="checkbox"/> Other	<input type="checkbox"/> Other	<input type="checkbox"/> Other	<input type="checkbox"/> Wood*

\*Fire Department Permit Required

I hereby agree to comply with the town subdivision regulations, Freedom growth management regulation, flood plain ordinance, state shoreland protection act, selectmen's town road specifications, fire codes, state air and water pollution permits (sewage etc.), state building codes and any other requirements in effect in the town of Freedom.

I hereby certify under penalty of perjury that the estimated cost of construction, alteration, or remodeling (including labor and material) is \$ \_\_\_\_\_

Date: \_\_\_\_\_ Owner/Agent Signature: \_\_\_\_\_

Code Officer: \_\_\_\_\_ Owner/Agent Print Name: \_\_\_\_\_

Valid for (1) One Year from Date Issued. Owner Address: \_\_\_\_\_

**New Hampshire Residential Energy Code Application**  
 for Certification of Compliance for New Construction, Additions and/or Renovations of  
 Detached One- and Two-family dwellings and multi-family dwellings (townhouses) not over 3 stories  
**EC-1 Form**

Minimum Provisions from 2015 IRC Chapter 11

Effective Date: September 15, 2019

<b>Owner/Owner Builder:</b> Company Name: (if applicable)			<b>General Contractor:</b> Company Name:		
Name:			Name:		
Mail Address:			Mail Address:		
Town/City:	State:	Zip:	Town/City:	State:	Zip:
Phone:	Cell:		Phone:	Cell:	
E-Mail:			E-Mail:		
<b>Location of Proposed Structure:</b>			<b>Type of Construction:</b>		
Tax Map #:		Lot #:	<input type="radio"/> Residential <input type="radio"/> Small Commercial <input type="radio"/> New Building <input type="radio"/> Renovation <input type="radio"/> Addition <input type="radio"/> Thermally Isolated Sunroom <input type="radio"/> Modular Home: the site contractor must submit this form detailing supplementary rooms and Floor and/or Basement insulation unless the floor insulation is installed or provided by the manufacturer and no heated space is added.		
Street:			<b>Total New Conditioned* Floor Area:</b> _____ ft <sup>2</sup>		
Town/City:	County:				
<b>Zone 5</b> <input type="radio"/> Cheshire, Hillsborough, Rockingham Strafford <b>Zone 6</b> <input type="radio"/> All other NH counties and town of Durham			<b>Basement or Crawl Space type:</b> (*a conditioned space is one being heated/cooled, containing uninsulated ducts or w/ a fixed opening into conditioned space. Walls must be insulated) Conditioned? <input type="radio"/> Yes (Walls must be insulated) <input type="radio"/> No <input type="checkbox"/> Full Basement <input type="checkbox"/> Walk Out Basement <input type="checkbox"/> Slab on Grade <input type="checkbox"/> Other _____		
<b>Structure is EXEMPT because:</b> <input type="checkbox"/> Mobile Home <input type="checkbox"/> On an historic register			<b>Form Submitted by:</b> <input type="checkbox"/> Owner <input type="checkbox"/> Builder <input type="checkbox"/> Other _____		

I hereby certify that all the information contained in this application is true and correct, and construction shall comply in all respects with the terms and specifications of the approval given by the local municipal code official or New Hampshire Public Utilities Commission.

Signature \_\_\_\_\_ Print Name \_\_\_\_\_ Date \_\_\_\_\_

<b>Official Use Only</b>	
Date Complete Application Received:	Approved by: _____ Date: _____
Approval Number:	Stamp:

## Footnotes to Residential Energy Code Application for Certification of Compliance

<sup>i</sup> Ceilings with attic spaces: R-38 in Zone 5 or 6 will be deemed to satisfy the requirement for R-49 wherever the full height of uncompressed R-38 insulation extends over the wall top plate at the eaves or the full R-value is maintained. This is often accomplished by using a raised heel or energy truss as shown in the diagram below or by using higher R-value insulation over the plates.

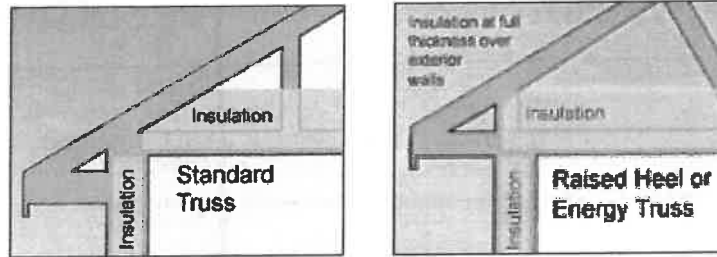

<sup>ii</sup> R-13 + R-5 means R-13 cavity insulation plus R-5 continuous insulated sheathing. If structural sheathing covers 25 percent or less of the exterior, R-5 sheathing is not required where the structural sheathing is placed. If structural sheathing covers more than 25 percent of exterior, the structural sheathing must be supplemented with insulated sheathing of at least R-2.

<sup>iii</sup> Slab edge insulation must start at the top of the slab edge and extend a total of two (Zone 5) or four feet (Zone 6). Insulation may go straight down, out at an angle away from the building, or along the slab edge and then under the slab. A slab is a concrete floor within 1' of grade level. See diagram below.

The top edge of insulation installed between the exterior wall and the interior slab may be mitered at a 45 degree angle away from the exterior wall.

### Allowable Slab Insulation Configurations

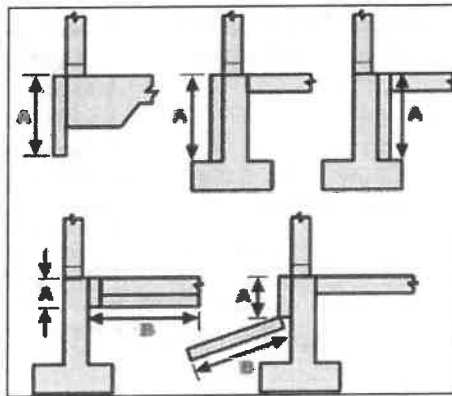

A or A+ B must equal two feet in Zone 5 or four feet in Zone 6

MODULAR HOMES must be certified by the NH Department of Safety. Unless the floor insulation is provided by the manufacturer this form may be submitted. This form may also be submitted if the basement is to be insulated or supplementary heated space is added to the home upon or after it is set.

<p><b>Duct Insulation</b> Code Section N1103.3.1</p>	<p><b>Supply and return</b> ducts in attics must be insulated to at least R-8 where 3 in. diameter or greater. All other ducts must be insulated to at least R-6. Exception: Ducts or portions thereof located completely inside the building thermal envelope.</p>
<p><b>Duct Construction</b> Code Sections N1103.3.2 and N1103.3.5</p>	<p>Ducts, air handlers and filter boxes shall be sealed. Joints and seams must comply with the <i>Int. Mech. Code</i> or Section M1601.4.1 of the <i>International Residential Code</i>. Building framing cavities <b>shall not</b> be used as ducts or plenums (neither supply nor return).</p>
<p><b>Duct Testing</b> Code Sections 1103.3.3</p>	<p>Ducts shall be pressure tested to determine air leakage by either 1) rough-in test or 2) post-construction test. See Code for requirement details.</p> <p>Test conducted by: _____</p> <p>Duct test result at 25 Pa: _____ Post construction or _____ Rough-in test</p>
<p><b>Temperature Controls</b> Code Section N1103.1&amp;1.1</p>	<p>At least one thermostat must be provided for each separate heating and cooling system. The thermostat controlling the primary system must be equipped with a programmable thermostat.</p> <p>Heat pumps having supplementary electric-resistance heat must have controls that, except during defrost, prevent supplemental heat operation when the heat pump compressor can meet the heating load</p>
<p><b>Mechanical System Piping Insulation</b> Code Section 1103.4</p>	<p>Mechanical system piping capable of conveying fluids at temperatures above 105°F or below 55°F must be insulated to R-3.</p>
<p><b>Circulating Hot Water Systems</b> Code Section N1103.5</p>	<p>Circulating service water systems must include an automatic or readily accessible manual switch that can turn off the hot water circulating pump when the system is not in use.</p> <p>Circulating domestic hot water system piping shall be insulated to R-4.</p>
<p><b>Mechanical Ventilation</b> Code Section N1103.6</p>	<p>Outdoor air intakes and exhausts must have automatic or gravity dampers that close when the ventilation system is not operating.</p>
<p><b>Equipment Sizing</b> Code Section N1103.7</p>	<p>Heating and cooling equipment shall be sized in accordance with ACCA Manual J or other approved heating and cooling calculation methodologies. Equipment shall have an efficiency rating equal to or greater than applicable federal standards.</p>
<p><b>Certificate</b> Code Section N1101.14</p>	<p>A permanent certificate, completed by the builder or registered design professional, must be posted on or in the electrical distribution panel. It must list the R-values of insulation installed in or on the ceiling, walls, foundation, and ducts outside the conditioned spaces; U-factors and SHGC for fenestration. The certificate must also list the type and efficiency of heating, cooling and service water heating equipment.</p>
<p><b>Existing Buildings and Structures</b>  See Appendix J of IRC</p>	<p>The purpose of these provisions is to encourage continued use of existing buildings and structures. Work in existing buildings shall be classified into categories of repair, renovation, alteration and reconstruction. Consult this Appendix for specific requirements related to work in existing buildings.</p>

# TOWN OF FREEDOM

## PERMIT FEE SCHEDULE

**1. NEW CONSTRUCTION – Additions, Residential Dwelling-Modular Homes**

45 cents per square foot of floor space                      MINIMUM \$60.00

**2. Accessory Buildings, Commercial, Industrial, Garages, Sheds, Utility Building, Ground Mount Solar, and Decks**

45 cents per square foot of floor space                      MINIMUM \$60.00

**3. FOR ALTERATIONS OR REPAIRS TO - Dwellings, Sheds, Garages, Decks, Roof Mounted Solar ETC.**

\$5.00 per one thousand dollars of construction                      MINIMUM \$60.00

**4. NEW CONSTRUCTION – Agriculture, Schools, Churches, Hospitals**

\$3.00 per one thousand dollars of construction                      MINIMUM \$60.00

**5. FOR ALTERATIONS, RENOVATIONS, ADDITIONS IN BUILDINGS LISTED IN #4**

\$3.00 per one thousand dollars of construction                      MINIMUM \$60.00

**6. MECHANICAL PERMITS – ELECTRICAL, PLUMBING, GAS PIPING / MECHANICAL**

\$70.00	up to 5,000 square feet
\$120.00	5,001 – 10,000 square feet
\$180.00	10,001 square feet and up

**On time Renewals shall be \$50.00. Renewals done after expiration date - \$5.00 per thousand of remaining construction costs.**

**7. MISCELLANEOUS**

- A. Mobile Homes    \$60.00
- B. Swimming Pools    \$60.00
  - Above Ground
  - In Ground
- C. Healthy Tree Removal                                      \$75.00\*
  - \*Plus noticing fee of \$15.00 per abutter
- D. Dead/Dangerous Tree Removal                      \$75.00
- E. STR Conditional Use Permit Application              Initial \$100.00    Renewal \$50.00
- F. Foundation    ½ the total permit cost
- G. Work Started without a permit                      \$100.00 flat fee + permit fee (Waived for Electrical, plumbing or structural emergency)

**8. REINSPECTION**

\$50.00 This fee will be charged for each inspection conducted after 2 failed attempts at obtaining approval for both rough and final inspections.

## Building Code Requirements

- All building permits require a zoning permit prior to the issuance of the permit.
- Building permits must be posted in conspicuous place on construction board.
- A current permit for construction of a septic system is required prior to the issuance of a building permit.
- Roof system per 2018 Building Code
- Stair geometry in residential homes per 2018 Building Code
- Hard-wired smoke detectors with battery backup are required. One on each level and one in every bedroom chamber. Power to the smoke detector circuit must be taken from a circuit that supplies a bedroom chamber or living room.
- An oil burner permit is required for all oil-fired heating systems, including replacement of systems. This permit is issued by the Town Fire Chief.
- Propane, Heat Pump, Central Air per Building Codes
- New driveways entering from town roads need a driveway permit from the town road agent.
- All new homes need to contact the Selectmen's Office for 911 house number at beginning of project.
- Bonding of the water piping system to the electric service grounding is required.
- A bonding conductor connected to the grounding electrode conductor for telephone and cable TV is required at their service entrance locations.
- Unheated basement must have their ceiling insulated and a door is required at the bottom of bulkhead stairways to meet NH energy code.
- Electrical requirements per 2017 NFPA 70
- Solar projects must provide an affidavit from engineer that they comply with all applicable building codes electrically and structurally.
- For any new or renovation of commercial structures. A third party independent fire safety review of proposed construction or renovation will be required. And follow NFPA 1: fire code, 2018 edition:
  - 1.15
  - 1.16

## Freedom Roads by Class

**NOTE: If your property is not located on a road on this list, your property is on a private road.**

### State Roads

Cushing Corner Road  
Eaton Road  
Elm Street  
Old Portland Road  
Porter Road  
Village Road

### Town Roads

Abenaki Drive  
Babcock Road  
Beach Club Drive  
Ben Road  
Bennett Road  
Black Road  
Burnham Road  
Charles Perry Road  
Chick Drive  
Cold Brook Road  
Durgin Hill Road  
E Danforth Road  
Fife and Drum Way  
Flintlock Lane  
Freedom Point Road  
Hampshire Road  
Hampton Lane  
Haverhill Street  
Hillside Drive  
Huckins Road  
Huntress Bridge Road  
Independence Drive  
Kidder Drive  
Liberty Lane  
Little Knoll Circle  
Loon Lake Road  
Marina Road

### Town Roads

Moulton Road  
Mudgett Drive  
Nason Road  
North Broad Bay Road  
Old Stagecoach Road  
Old West Ossipee Road  
Olde Yankee Drive  
Ossipee Lake Road  
Packard Drive  
Patriots Way  
Paul Hill Road  
Pauli Point Road  
Pequawket Trail  
Powder Horn Lane  
Rice Hill Road  
Round Pond Road  
Scarboro Road  
Shawtown Road  
Sherwood Forest Way  
Stoddard Lane  
Swett Hill Road  
W Danforth Road  
Watson Hill Road  
West Bay Road  
York Lane  
Youngs Hill Road

PERMITTED USES BY DISTRICT	VR	GR	RR	R/LC	SF
1. Single family dwelling	X	X	X	X	
2. Agriculture	X	X	X	X	
3. Forestry	X	X	X	X	
4. Produce Stand	X	X	X	X	
5. Water Storage Facility	X	X	X	X	
6. Residential Camping	X	X	X	X	
7. Elderly Housing	X	X	X	X	
8. Attached Accessory Dwelling Unit	X	X	X	X	
9. Minor Home Occupation Amended	X	X	X	X	
10. Wireless Telecom Service Facility	X	X	X	X	
11. Manufactured Housing		X	X	X	
12. Cluster Development		X			
13. Retail Store				X	
14. Automobile Service Station				X	
15. Office				X	
16. Outdoor Recreational Facility					X
17. Accessory use such as beach, dock, driveway					X
18. Erosion control for projects eligible for a permit by notification					X
19. Accessory use to a permitted use	X	X	X	X	

SPECIAL EXCEPTION USES	VR	GR	RR	R/LC	SF
1. Tourist home	X	X	X	X	
2. Major Home occupation	X	X	X	X	
3. Elderly group home	X	X	X	X	
4. Private school	X	X			
5. Church	X	X		X	
6. Office		X			
7. Clinic		X			
8. Community Building		X			
9. Hospital		X			
10. Hotel		X			
11. School		X			
12. Residence Camp		X	X		
13. Recreational Camping or Camping Park		X	X		
14. Outdoor Recreational Facility			X		
15. Animal Hospital			X		
16. Light Commercial					
17. Single-family Workforce Housing (Limited)		X	X	X	
18. Multi-family Workforce Housing				X	
19. Off-lot parking facility		X	X	X	
20. Marina					
21. Shore front common area					X
22. Erosion control for projects not eligible for a permit by notification					X
23. Cutting and removal of trees and natural vegetation					X
24. Accessory use to a permitted use	X	X	X	X	X

**Freedom Streams for Stormwater Management Plans**

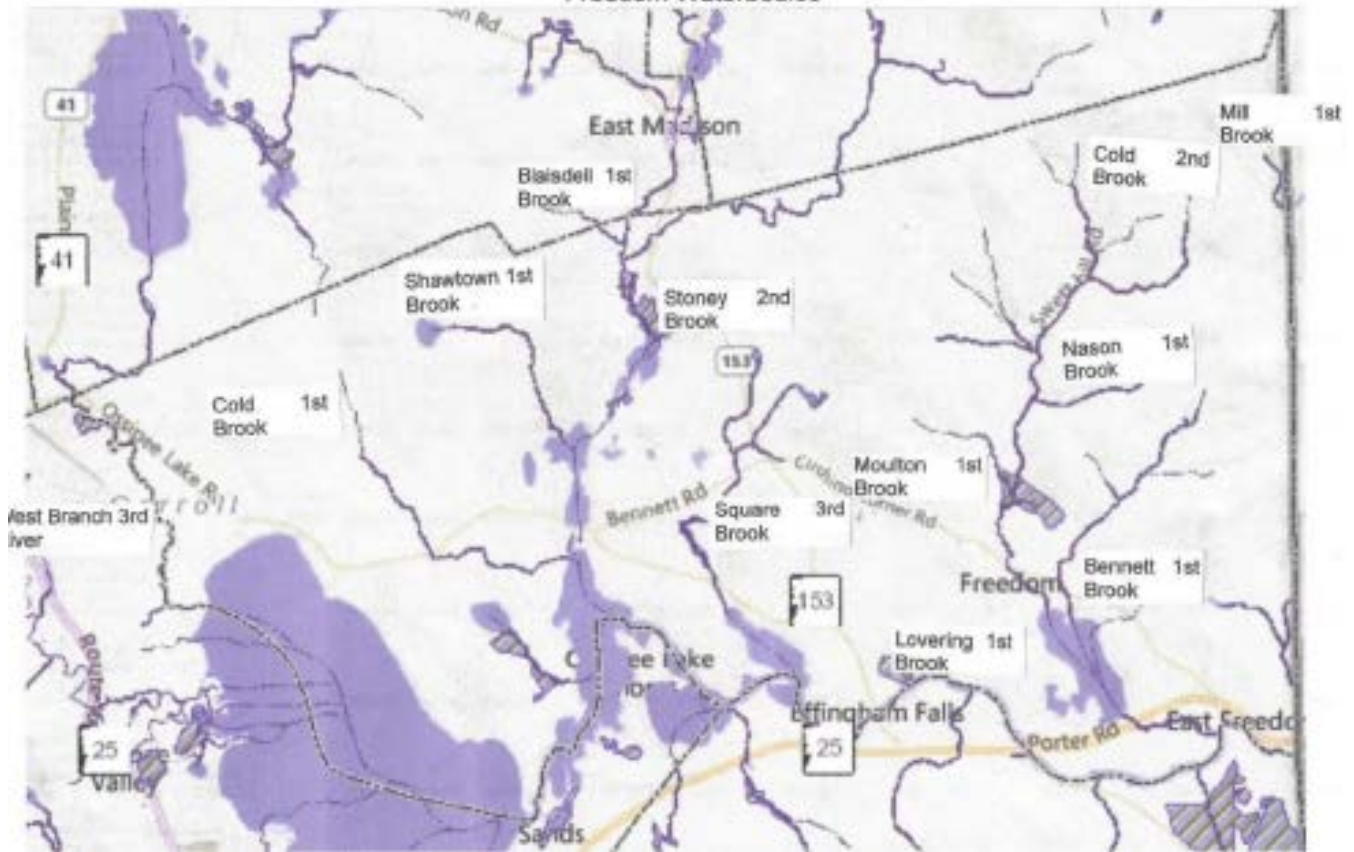

<u>Waterbody</u>	<u>Order</u>	<u>Location</u>
Bennett Brook	1st	headwater north of Scarboro Rd follows Scarboro Rd to Loon Lake
Blaisdell Brook	1st	headwater Blazo Mt to Stoney Brook to Upper Danforth
Cold Brook	2nd	headwater Cold Brook Rd to Loon Lake to Ossipee River
Cold Brook	1st	headwater north of town forest to Broad Bay
Lovering Brook	1st	Village Rd to Ossipee River
Mill Brook	1st	north of Rice Hill Rd to Bickford Pond
Moulton Brook	1st	joins Cold Brook at Moulton Rd to Loon Lake to Ossipee River
Nason Brook	1st	joins Cold Brook at Moulton Rd to Loon Lake to Ossipee River
Shawtown Brook	1st	headwater Trout Pond to Middle Danforth Pond
Square Brook	3rd	headwater Rt 153 to Berry Bay to Ossipee River
Stoney Brook	2nd	headwater Ben Hill to Upper Danforth
West Branch River	3rd	flows from Silver Lake into Ossipee Lake

*Source: NH Fish and Game Topographical Maps*

## EXAMPLE Stormwater Management Plan

Creating a project plan allows you to take a comprehensive look at your property. Through thoughtful observation you can follow the path that stormwater flows through your property from its source to its ultimate endpoint. Once these details are identified, you can start planning where you might be able to install one or more of the stormwater practices described in this guide to intercept flow and soak up the rain. Finally, you can use the Residential Loading Model to calculate your property's stormwater footprint and the water quality benefit a stormwater practice would provide.

### 1. MAP YOUR PROPERTY

Map your property using an aerial photo or by hand using graph paper. Using a grid will help you draw your house, driveway, and other property features to scale. Other resources available to map your property include:

- Google Maps or other online imagery
- Municipal offices/web site - tax map, online GIS (if available)
- Approved septic system plan, if you have a septic system

#### EXISTING CONDITION

Map or sketch your property the way it currently exists (Figure 1). It is useful to make copies of your existing condition map to use to sketch different ideas for your planned future condition.

#### PLANNED CONDITION

Sketch proposed changes and property improvements such as building an addition, deck or storage shed, clearing trees to expand your lawn, or installing a stormwater practice, like a rain garden or rain barrel.

#### HELPFUL TOOLS

Gather the following materials to help create your project plan.

- ↳ Measuring tape
- ↳ Ruler
- ↳ Calculator
- ↳ Shovel
- ↳ Bucket or waterproof container
- ↳ Paper and Pen
- ↳ Graph paper
- ↳ Tax map or aerial photo of your property with lot lines

Illustrations in Appendix B by Braden Drypolcher

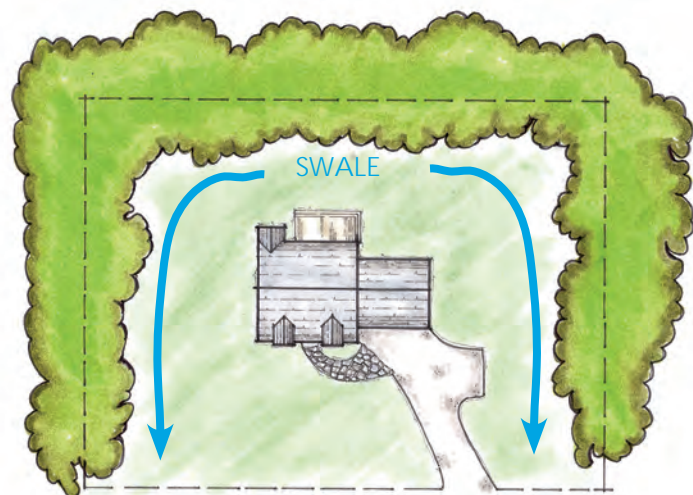

Figure 1. Example existing conditions map.

## 2. IDENTIFY PROPERTY DETAILS

Identify and record the following features of your property:

### Lot Size

The size of your lot should be on your property tax assessment, the deed to your house, the purchase and sales agreement for your home, on your town's web site, or you can contact your town offices.

### Break Down of Land Cover Types

Estimate the area of each land use type by doing the following.

#### *Impervious Roof*

Measure the length and width of your house, garage, and any other structure that has a roof and multiply to get the area (Figure 2).

Add the roof areas together to get the total impervious roof area for the property.

#### *Other Hard Surfaces*

Other hard surfaces include driveways, walkways, decks, patios, or other surfaces that prevent water from soaking into the ground. Measure the average length and average width of these areas and multiply to get the area (Figure 3).

Add the areas together to get the total other hard surfaces area for the property.

#### *Lawn and Landscaped Areas*

Lawn and landscaped areas include any areas with grass or gardens that you regularly maintain. Measure the average length and average width of each of these areas and multiply to get the area (Figure 4).

Add the areas together to get the total lawn/landscaped area. If your property has no natural or forested areas on it, you can simply subtract the impervious roof and other hard surface areas from your total lot size to get the lawn/landscaped area.

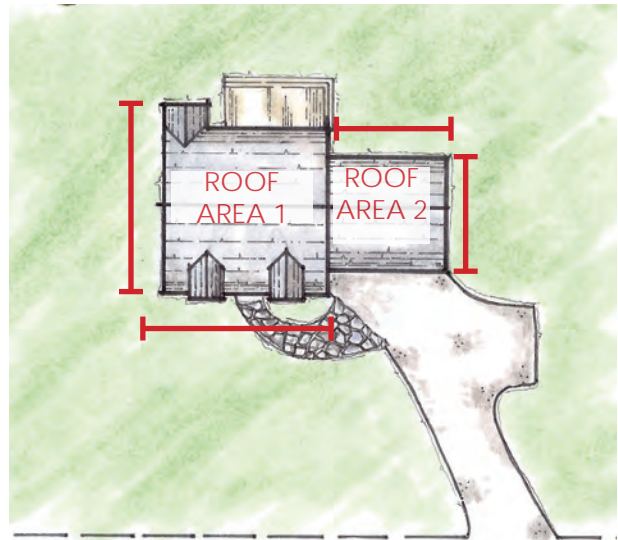

Figure 2. Measuring impervious roof areas.

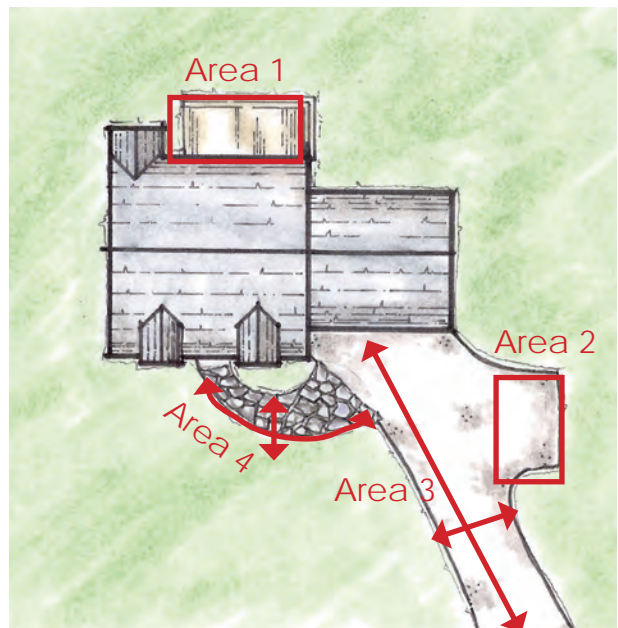

Figure 3. Measuring other hard surface areas.

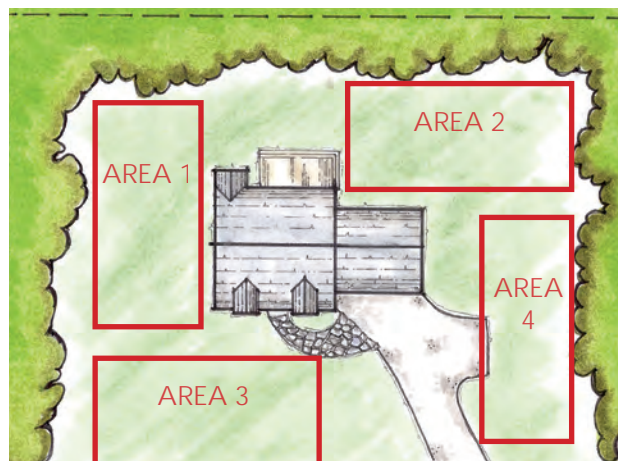

Figure 4. Measuring lawn areas.

### *Forested or Natural Areas*

Forested and natural areas include any areas that are naturally vegetated and are not actively maintained. Measure the average length and width of these areas and multiply to get the area. Then add the areas together to get the total forested area.

Alternatively subtract the impervious roof, other hard surfaces, and lawn/landscaped areas from the total lot size to get the forested/natural area of your property.

### *Other Features*

#### **Roof Downspouts**

If you have gutters on your house, follow them along the roof line to the downspouts. There may be more than one downspout on your house. Identify downspout locations and other areas, such as roof valleys where rain collects and runs off of your roof. This will help you plan the best placement for stormwater treatment practices to capture roof runoff.

#### **Vegetated Buffer Areas**

Identify vegetated buffer areas such as trees or other vegetated areas at the edge of your property boundary or around features on your property such as streams, wetlands, or steep slopes.

#### **Steep Slopes & Other Vulnerable Areas**

Identify any areas on your property with steep slopes and areas that regularly erode. Existing rills or gullies in the soil or exposed roots and rocks identify areas that may have erosion problems. Planting or allowing natural vegetation to grow along the top of the slope to create a buffer can protect against slope erosion.

#### **Stormwater Treatment Practices**

Identify any existing or planned stormwater treatment practices and their approximate location on your property.

#### **Streams or Ponds**

Identify any streams or ponds on or near your property. You can look up the water quality of those waterbodies to see if they have any existing pollution problems or impairments to consider in the New Hampshire Surface Water Quality Assessment at [www.des.nh.gov/organization/divisions/water/wmb/swqa/index](http://www.des.nh.gov/organization/divisions/water/wmb/swqa/index).

### **3. IDENTIFY HOW AND WHERE STORMWATER FLOWS**

When rain hits the ground, it flows over and through your yard. Some of it finds places to soak into the ground or low spots to puddle, and the rest of it may run off of your property. Using the property maps that you created, you can estimate how and where stormwater runoff flows on your property by following the steps below.

1. Pretend you're a raindrop (or better yet, watch a real rain storm). Identify high points in your lawn or driveway. Observe the directions that water flows and the places where the water ends up (the stormwater endpoints). These could be places where water puddles, where it enters a catch basin, or where it enters or could enter a stormwater practice that you install.

2. Draw a boundary line on your project map around the area that drains to each stormwater endpoint. The boundary line represents the "drainage area" or watershed for each stormwater endpoint. For example, if all of the runoff from the back of your garage roof drains to a single gutter downspout, the roof is the drainage area to the stormwater endpoint at the downspout. And if the right side of your yard all drains toward the road, that is a separate drainage area. You can identify these drainage areas on your property map by drawing a line around their perimeters (Figure 5).

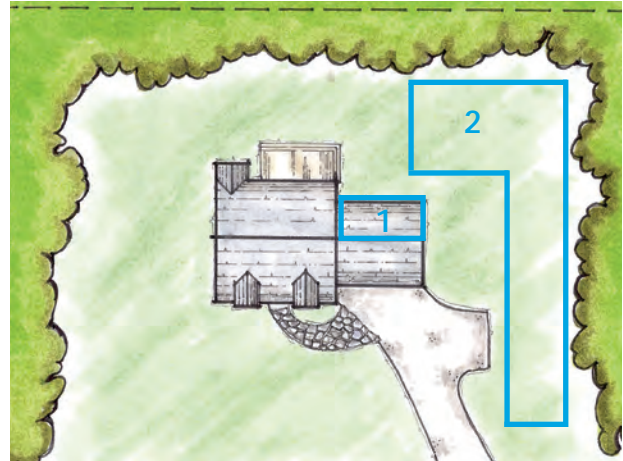

Figure 5. Draw the boundary lines (drainage areas) for stormwater endpoints.

3. To estimate the size of each drainage area measure the approximate length and width and multiply to get the area or, if you used grid paper to scale your map, you can count the squares within each boundary line.

#### 4. ESTIMATE HOW MUCH STORMWATER RUNOFF YOUR PROPERTY CREATES

The roof and other hard surfaces (i.e., impervious areas) on your property create the most stormwater runoff. While lawns and landscaped areas contribute to the stormwater problem, managing the runoff that comes from impervious surfaces is the best way to reduce stormwater runoff and pollution.

To estimate the amount of stormwater runoff that your property creates, complete the following steps:

1. Add up all the areas of impervious roof and other hard surfaces (ft<sup>2</sup>) that you identified in Step 2.
2. Most storms in New Hampshire produce 1" of rain or less. To determine the volume of stormwater created during a storm that produces 1-inch of rain, multiply the total area of impervious (from above) by 1-inch, then divide by 12. Keep in mind that some storms produce greater than an inch of runoff. Stormwater treatment practices could be oversized to reduce overflow or the practice could be designed to direct overflow to another treatment practice or a designated pervious area.

$$(\text{IMPERVIOUS AREA}_{\text{total}} \text{ ft}^2) \times (1 \text{ inch} / 12) = \text{STORMWATER VOLUME (ft}^3\text{)}$$

#### 5. SELECT A LOCATION, TEST THE SOIL, AND SELECT A STORMWATER PRACTICE

Refer to the Getting Started section of this guide on page 10 for instructions on selecting appropriate locations, testing the soils, and selecting a stormwater practice for your site.

## 6. PREPARE A PROJECT PLAN

Using a copy of your existing conditions map, create your project plan by combining all of your property details (from Step 2), how and where water flows (from Step 3), soil information and selection of location and stormwater practices (from Step 5) into one document. Include proposed changes and improvements to the property such as building new structures like a deck or storage shed, clearing trees to expand your lawn, or installing a stormwater practice, like a rain garden or rain barrel.

Chapter 4, The Landscape Design Process, from [\*Landscaping at the Water's Edge An Ecological Approach\*](#) provides detailed instructions for preparing a project plan.

## 7. ESTIMATE YOUR STORMWATER FOOTPRINT

Take your project one step further by using the NH Residential Loading Model to estimate your stormwater footprint.

The NH Residential Loading Model was developed by the NH Department of Environmental Services specifically for property owners to use to estimate the amount of sediment and nutrients, specifically phosphorus and nitrogen, running off of your property. This model can be used to:

- Calculate a property's "stormwater footprint", which is how much sediment, phosphorus, or nitrogen runs off of a property.
- Calculate the water quality benefit of installing stormwater treatment practices on your property.
- Compare the existing and planned future condition of your property with different stormwater treatment scenarios to see the difference in stormwater runoff volume and pollutant amounts.

The NH Residential Loading Model is available in a web-based format on the Winnepesaukee Gateway at <http://winnepesaukeegateway.org/resources/phosphorus-calculator/> or in a spreadsheet format at [www.des.nh.gov/organization/divisions/water/stormwater](http://www.des.nh.gov/organization/divisions/water/stormwater).